



Leica EG 1160

Paraffin Embedding Center

Instruction manual

Leica EG 1160 V4.1 English – 05/2001

Always keep this manual near the instrument!
Read carefully prior to operating the instrument!

Leica
MICROSYSTEMS

Serial No.
Year of manufacture
Manufactured in: Federal Republic of Germany

The information, numerical data, notes and value judgments contained in this manual represent the current state of scientific knowledge and state-of-the-art technology as we understand it following thorough investigation in this field. We are under no obligation to update the present manual periodically and on an ongoing basis according to the latest technical developments, nor to provide our customers with additional copies, updates etc. of this manual.

For erroneous statements, drawings, technical illustrations etc. contained in this manual we exclude liability as far as permissible according to the national legal system applicable in each individual case. In particular, no liability whatsoever is accepted for any financial loss or consequential damage caused by or related to compliance with statements or other information in this manual.

Statements, drawings, illustrations and other information as regards contents or technical details of the present manual are not to be considered as warranted characteristics of our products. These are determined only by the contract provisions agreed between ourselves and our customers.

Leica reserves the right to change technical specifications as well as manufacturing processes without prior notice. Only in this way is it possible to continuously improve the technology and manufacturing techniques used in our products.

This document is protected under copyright laws. Any copyrights of this document are retained by Leica Microsystems Nussloch GmbH.

Any reproduction of text and illustrations (or of any parts thereof) by means of print, photocopy, microfiche, web cam or other methods – including any electronic systems and media – requires express prior permission in writing by Leica Microsystems Nussloch GmbH.

For the instrument serial number and year of manufacture, please refer to the name plate at the back of the instrument.



MICROSYSTEMS

Leica Microsystems Nussloch GmbH

Heidelberger Strasse 17-19
D-69226 Nussloch
Germany

Telephone 0 62 24/143 - 0
Telefax 0 62 24/143 - 200
eMail: histo_info@leica-microsystems.com
Internet: <http://www.histo-solutions.com>

© Leica Microsystems Nussloch GmbH

2. Table of contents

1.	Important information	3
2.	Table of contents	4
3.	Installation	5
4.	Technical data	6
5.	General description	7
6.	Safety precautions	8
7.	Leica EG 1160 – Overview	10
8.	Components and features	12
9.	Controls / Display	16
10.	Operation	17
11.	Tissue embedding	24
12.	Cleaning, maintenance, service	26
13.	Troubleshooting	28
14.	Ordering information	31
15.	Warrenty and service	32

The Leica EG 1160 is a compact bench-top unit and can be set up easily. All components come in a cardboard box. The components that are packed separately can be attached to the instrument easily (*see page 5 "Part list"*).

1. Transport and assembly position

The Leica EG 1160 must never - not even for a short while - be positioned as shown. These positions will inevitably cause damage to the condenser. Therefore, please check the Tip-N-Tell indicators which are attached to the package upon receipt.

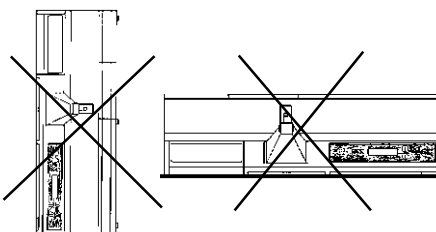

Should it become necessary to bring the instrument in a position other than normal, lay the instrument on its back turning it slowly and carefully.

2. Unpacking

The instrument may **only** be lifted holding it at the sides of the base plate of the housing. Do not carry the instrument holding it at the top cover, at the front handholds of the removable trays or the dispenser. Risk of fracture!

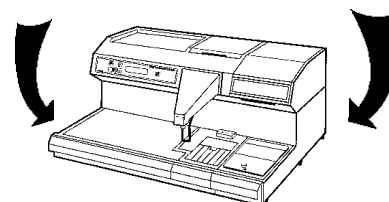

3. Place of installation

The instrument should be set up on a stable, plane laboratory table. Please

ensure that there is no air condition vent nearby.

The location must fulfil the following conditions to ensure that air circulation is not affected. The back of the instrument must be at least 15 cm away from the wall. The shipment includes two spacers which must be attached to the back. Non-compliance with this minimum distance can cause substantial damage to the instrument and will invalidate the warranty.

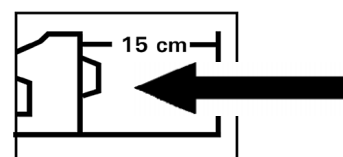
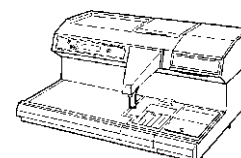

4. Power supply

Prior to connecting the instrument to the mains outlet, please ensure that the power supply specified on the nameplate complies with the local mains conditions.

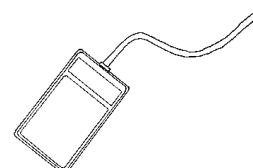

5. Foot pedal

The foot pedal is connected to the socket in the right-hand bottom corner on the back.

4. Technical data

Power supply:	115 V / 60 Hz 230 V / 50 Hz	Dimensions: (LxDxH)	910 x 575 x 320 mm	Programmable parameters:
Fuses:	115V/60Hz F1, F2 = T5.0 A 230V/50Hz acc. to IEC 127-2	Weight:	50 kg	Temperature
Power consumption:	800 VA	Capacities:		Paraffin reservoir
Operating temperature range:	18°C - 35°C	Paraffin reservoir:	3 l	Mold warmer
Cooling system:		Cassette bath:	approx. 100 cass.	Cassette bath
Refrigerant:	140 g ± 5g R134A	Heated		Work surface
Compressor oil:	150 ccm EMKARATE RL15S	recessed area:	8 cassettes	Cold plate
		Cold plate:	approx. 60 blocks	Workdays
				Daily work times (beginning, end)
				Weekday
				Time
				Operation either manual or via the foot pedal.

Temperature control

Functional unit	Temperature range	Heated separately	Separate temperature control	Warm-up time prior to operation
Paraffin reservoir	45 - 70°C, ± 1°C increments	+	+	4 h
Mold warmer	35 - 70°C ± 1°C increments	+	+	1 h
Cassette bath	45 - 70°C ± 1°C increments	+	+	1.5 h
Work area	45 - 70°C ± 1°C increments	+	+	1 h
Cold plate	- 5°C	-	-	1 h
Forceps holder right	70°C	+	-	
Forceps holder left (not basic instrument)	70°C	+	-	
Paraffin dispenser + pump	45 - 70°C	+	-	

* at an ambient temperature of 22°C and at an air humidity of 60%

All heated components include overheat protection.

Features

1. Paraffin flow rate is pump controlled.
2. Paraffin flow rate adjustable in 10 increments
3. Paraffin quantity level indicated in the display
4. Separate paraffin collecting tray
5. Removable cassette bath
6. Forceps holder on the right (basic instrument) or on the right and left (not basic instrument)
7. Paraffin dispenser with integrated illumination
8. User menu available in 5 languages
9. Fault detection by error codes in the display
10. Optional accessories: Magnifier, vacuum attachment, fiber optical light guide (for connection to the coldlight sources of the Leica CLS series)

The Leica EG 1160 is a modern tissue embedding center providing all features required for rapid, convenient and efficient paraffin embedding of tissue including a separately heated 3-liter capacity paraffin reservoir. Paraffin quantity level shown on LCD display in two steps. Separately heated paraffin delivery system with integrated filter and pump ensure a smooth, consistent paraffin flow. The paraffin flow rate is adjustable in 10 increments.

The paraffin outlet nozzle can be operated either manually or via foot pedal. A non-glare illumination is integrated at the paraffin dispenser outlet to provide a well lighted work area.

The separately heated mold warmer to the right of the paraffin reservoir is designed to store and heat the molds prior to embedding.

The work area is divided into three parts: Cassette storage, working and embedding area and cold plate. The cassettes containing the tissue are stored in a separately heated, removable tray with a capacity of approx. 100 specimen capsules.

The large work area ensures convenient block removal and easy access to the cassettes. The forceps holder(s) is/are designed to accommodate three forceps and is/are integrated in the instrument. The heated recessed area behind the dispenser handle is designed to keep the par-

affin in the cassette molten. Excess paraffin can be drained through an outlet after the removing the stopper.

In front of the paraffin dispenser outlet a refrigeration spot is integrated in the cold plate ensuring optimal cooling. The large cold plate provides space for more than 60 embedding molds. A removable tray is located under the work area to collect excess paraffin drained from the work area.

The Leica EG 1160 is operated and programmed via a menu-driven control board. The menu is displayed in German, English, French, Spanish or Italian as selected. All operations are microprocessor-controlled.

Malfunctions are indicated by a numerical error code in the display. A battery backup prevents loss of all programmed parameters if a power failure occurs.

The individual functional units of the Leica EG 1160 are ergonomically positioned to enable rapid and convenient operation. The instrument may be operated by qualified personnel only in accordance with this operating instruction manual.

If used in accordance with the operating instructions and appropriate maintenance is ensured, the tissue embedding center will operate trouble-free and give perfect embedding results for many years.

6. Safety precautions

- The instrument may be used by qualified personnel only.
- To avoid any operating mistakes from the beginning, it is necessary to read the operating instructions to familiarize oneself with the technical details.

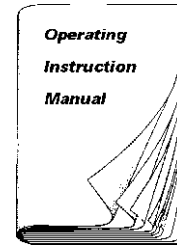

- Paraffin is flammable and should be handled with care. Spillage should be avoided. Paraffin on the surfaces must not be removed with sharp tools as it would ruin the coating. It should be avoided to allow xylene to react on all surfaces.

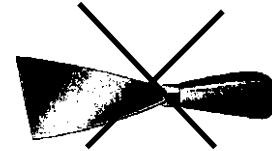

Caution:

Xylene is a flammable organic solvent. Its flash point is between 27 and 32°C. Xylene vapours are heavier than air and can easily catch fire on hot surfaces or sparks even over a greater distance.



- Illumination: Before replacing the lamp, the tissue embedding center must be turned off with the main switch.
- To clean the condenser fins, switch the instrument off with the main switch and disconnect it from mains.

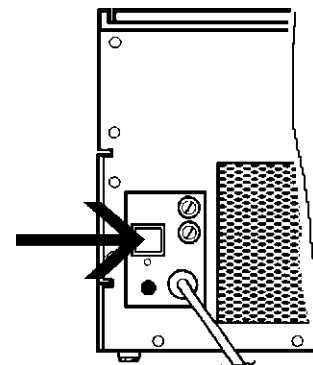

- To replace the fuses, the power cord must be disconnected from the power supply. Only fuses that are accessible from outside can be replaced. If you need further information, please contact your local Leica sales office or dealer.

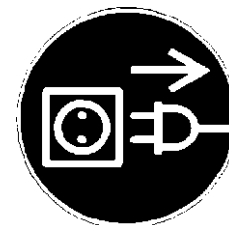

- When operating, the paraffin reservoir, mold warmer, cassette bath, work area and forceps holder are all hot.

Caution: Risk of burning!

Note: Combustible and flammable substances must not be stored near the instrument!



6. Safety precautions

- When using the optional vacuum attachment, please ensure that, after infiltration, the vacuum is neutralised very slowly. Therefore, open the aeration knob very cautiously. Air entering too rapidly could cause hot paraffin to splash and should therefore be avoided.

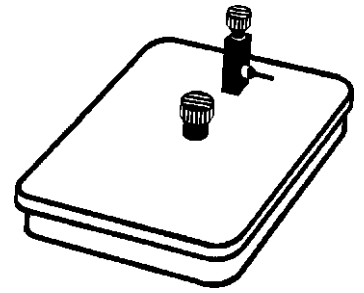

- Prior to connecting the instrument to the power supply in the laboratory, please make sure that the power supply complies with the values specified on the nameplate. The tissue embedding center should be connected to a grounded socket only.



- The equipment must not be set up near an air condition vent or should not be exposed to direct sunlight!

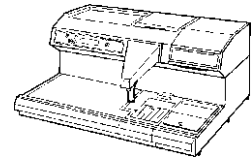

- Full refrigeration capacity is ensured only if the clearance on the back of the instrument is not less than 15 cm. Therefore, it is necessary to mount the spacers provided.

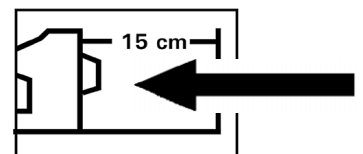

- Prior to any maintenance and service action, the tissue embedding center must be disconnected from the power supply.

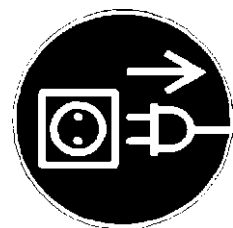

7. Leica EG 1160 – Overview

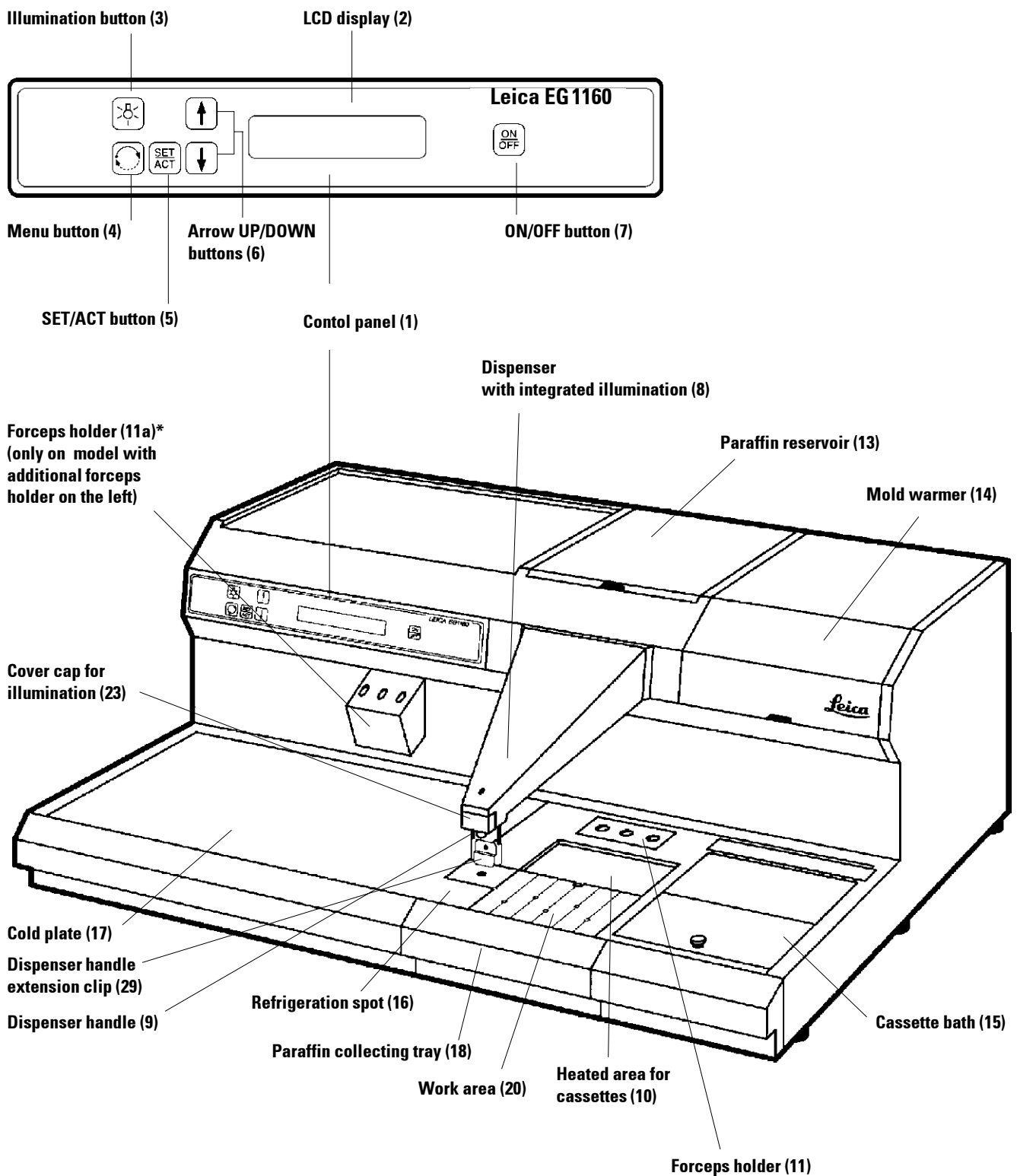

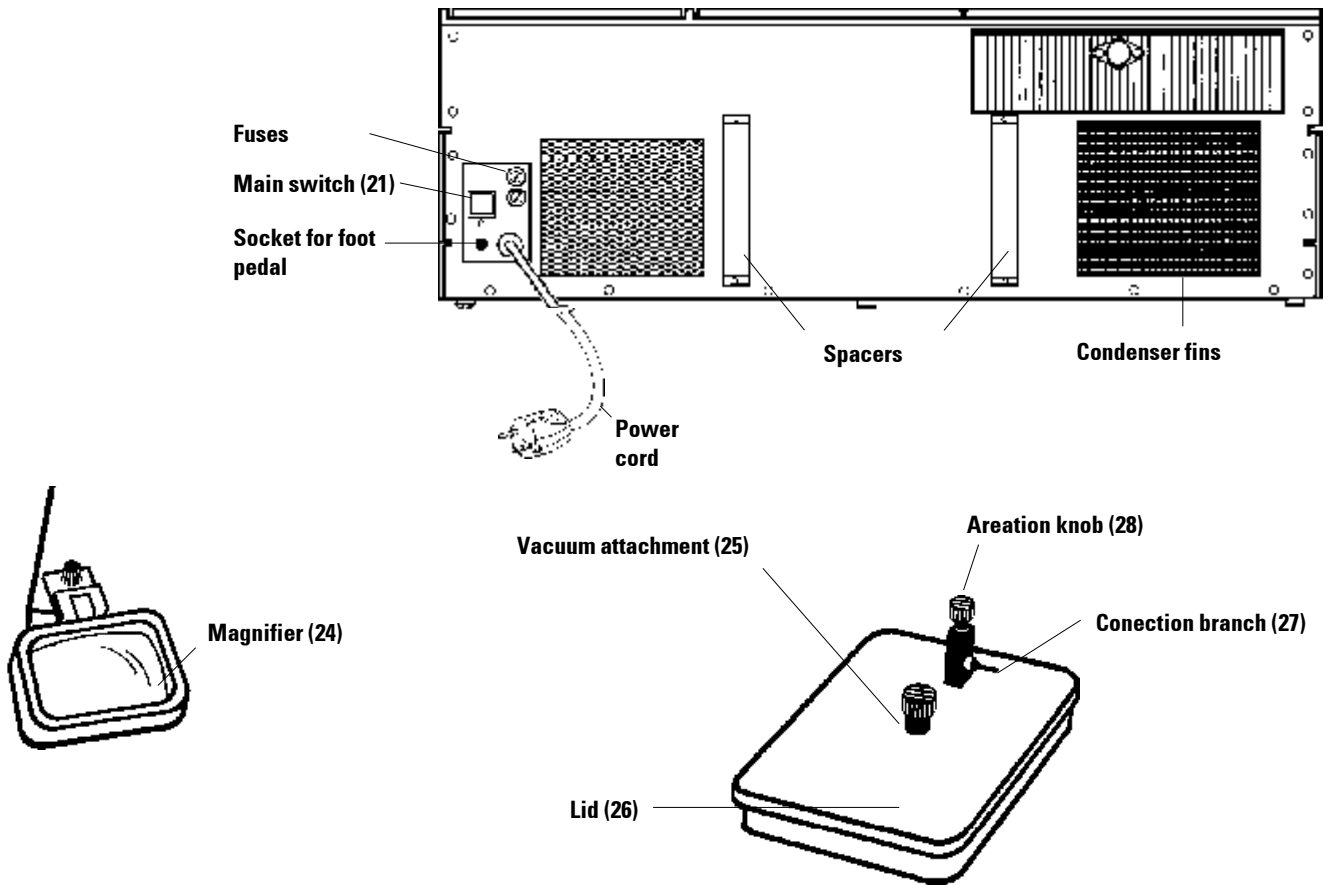

The Leica EG 1160 is a compact benchtop unit. It is available in two different configurations: basic instrument and model with an additional forceps holders on the left. Both models are shipped in a wooden crate. Please check if the following accessories are included in the shipment and if they are in perfect condition.

NOTE: If equipment or accessories are found to be damaged, please keep the original packing material and contact your local sales office immediately.

Pieces	Accessory/Component	Catalog Number
1	Cassette bath	0386 19544
1	Foot pedal	0356 08793
2	Spacers	0386 24590
1	Set of stoppers (10 pcs.)	0386 24782
1	Replacement bulb	0187 21220

Optional accessories:

1	Magnifier	0386 21462
1	Vacuum attachment	0356 21980
1	Fiber optical light guide	0386 31352
1	Coldlight source Leica CLS 100 -	
	100 V, 50/60Hz	0502 30213
	120 V, 50/60Hz	0502 30214
	230 V, 50/60Hz	0502 30215
	240 V, 50/60Hz	0502 30216

If you need further accessories, please contact your Leica sales office or dealer using above ordering information.

8. Components and features

Paraffin reservoir (13)

The paraffin reservoir can hold up to 3 liters. The paraffin temperature can be adjusted in a range from 45 to 70°C. The reservoir has an overheat protection in case of a temperature control failure. The paraffin quantity level is indicated in the display graphically both in the standby and operating condition. The display indicates two levels:

1. Reservoir filling quantity: 1 l - 3 l
2. Reserve: max. 1 l

When the "reserve" diagram is indicated, there is still approximately 1 liter in the reservoir, so it is not necessary to interrupt work immediately. Nevertheless, it is necessary to refill the paraffin reservoir as soon as possible.

A grid inside the paraffin reservoir provides that only molten paraffin flows through the dispenser outlet nozzle to ensure troublefree embedding. An integrated filter at the junction point of dispenser and reservoir prevents any contamination of molten paraffin.

Each refill of the reservoir can cause the formation of air bubbles that impede a smooth paraffin flow. This can be overcome by pushing the paraffin dispenser handle until a smooth flow is achieved..

The paraffin flow rate is adjustable in 10 increments (*see "Initial operation", "Controls"*).

A pump ensures a smooth and precisely controlled paraffin flow. Due to its special design, the pump is protected against damage by solid or semiliquid paraffin.

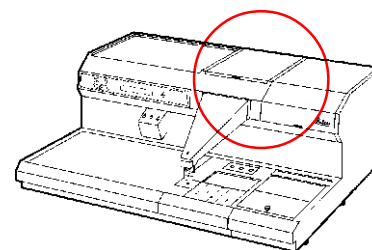

Paraffin dispenser with illumination (8)

The dispenser is separately heated and always has the same temperature as the paraffin reservoir. The dispenser handle (9) is used for manually operating the paraffin flow and is provided with a dispenser handle extension clip (29). The paraffin flow is released by lightly pushing the mold backward against the extension clip of the dispenser handle, thus opening the dispenser valve and activating the pump. Releasing the handle, a spring causes it to return to the start position. Thus, the valve is shut and the pump operation is stopped. When dispensing is controlled with the foot pedal, the dispenser handle is not needed and can be flipped back out of the way. This provides ample space allowing convenient filling of larger molds.

The homogeneous, diffuse illumination of the embedding area and refrigeration spot provides an optimal view of the embedding process and specimen orientation. The light bulb can be removed after removing the cap (23).

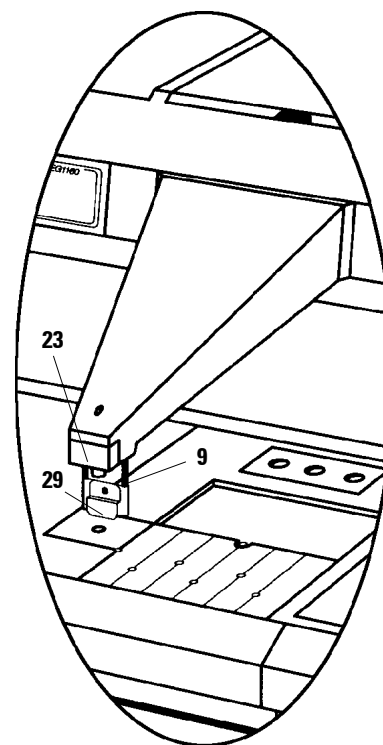

Mold warmer (14)

The temperature of the mold warmer is adjustable from 35 to 70°C. The hinged lid can be locked in position while open.

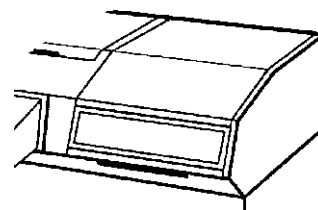

Cassette bath (15)

The cassette bath temperature is adjustable from 45 to 70°C. The cassette bath can hold more than 100 cassettes. It can be easily removed. An integrated lid protects against thermal loss and contamination.

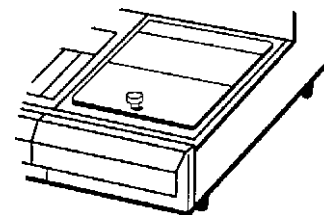

Refrigeration spot (16)

The refrigeration spot is integrated in the cold plate thus ensuring consistent, low temperatures. Positioned directly in front of the embedding area it ensures convenient filling of the molds in optimal ergonomic conditions. The mold containing the sample is filled approximately one third and placed on the refrigeration spot, where the paraffin starts to solidify rapidly. In the semiliquid paraffin the sample can be oriented as required. After orientation, the mold is filled up with paraffin. Note: Care should be taken that the paraffin does not become too solid during orientation, as this could cause an inhomogeneous block which would make sectioning more difficult.

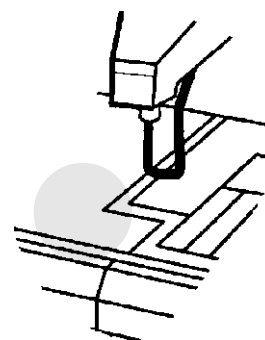

Cold plate (17)

The cold plate is turned on and off via the menu. The temperature is -5°C. The rate of cooling at -5°C ensures optimal consistency of the blocks and minimises the risk of brittleness as a result of too rapid cooling, and a high level of productivity. The cold plate provides ample space for approximately 60 paraffin blocks. Controlled cooling ensures that the preselected temperature is accurately maintained. Before starting to work, the cold plate should be free of paraffin and dry to prevent frost buildup.

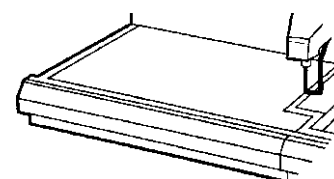

Paraffin collecting tray (18)

A large removable tray is located under the heated work area to collect excess paraffin drained from the surface. The paraffin that collects in the tray should not be reused. The tray should be emptied every day.

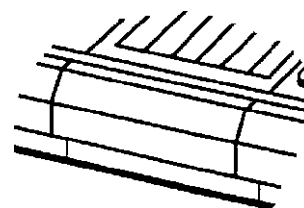

8. Components and features

Work area (20)

The temperature of the work area is adjustable from 45°C to 70°C. It includes the embedding area, forceps holder (11), recessed area for cassettes (10) and space to remove the lids. The forceps holder (11) is separately heated. The heated recessed area is designed for approximately eight cassettes. By closing the drain hole with the stopper provided, it can be utilised as a paraffin tray. Several grooves and drain holes in the area where the lids are removed provide that molten paraffin drains rapidly.

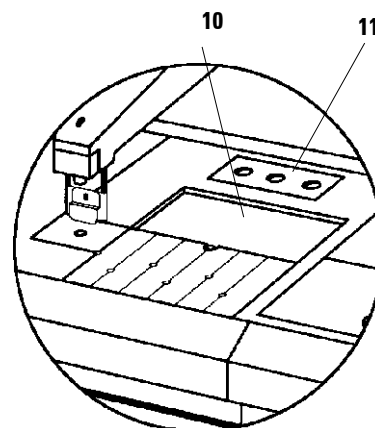

Main switch (21)

The main switch - a green toggle switch - is located on the back of the instrument. It is not necessary, however, to turn the instrument off with the main switch after daily operation.

In daily routine, the tissue embedding center should be switched on and off with the ON/OFF button on the control panel.

Note:

If the Leica EG 1160's automatic turn-on feature is used, i. e. if it is programmed to turn on automatically to be ready to operate when the user arrives, the main switch must be in the ON condition.

Note:

After a power failure, the Leica EG 1160 will not switch on automatically. At that stage, it is in the standby condition, just like after turning it on with the main switch, i.e. you have to set it going pushing the ON/OFF switch.

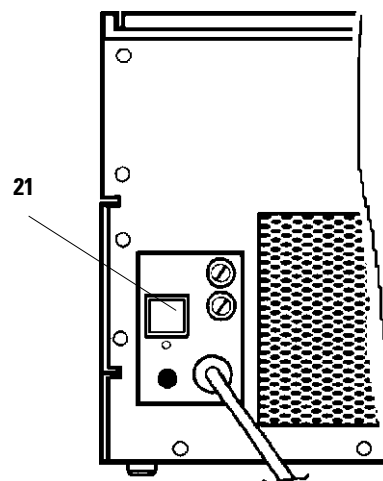

Cooling

Whenever the instrument was disconnected from mains, for example after a power failure or when it had been turned off with the main switch, it will take 10 minutes until the condenser of the cooling system is ready to operate.

Cover cap for illumination (23)

The cover cap for the light bulb is inserted at the front of the paraffin dispenser. For light bulb replacement, the cap is pulled towards the operator.

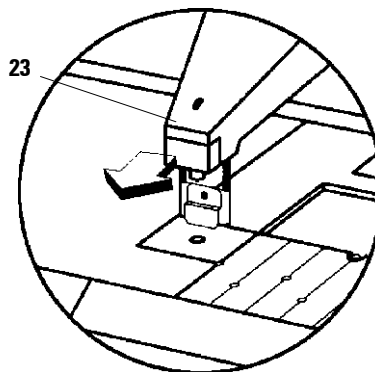

Instrument with additional forceps holder on the left

Forceps holder left (11a)

The instrument configuration with an additional forceps holder on the left covers the needs of left-handers in particular. This forceps holder also is separately heated.

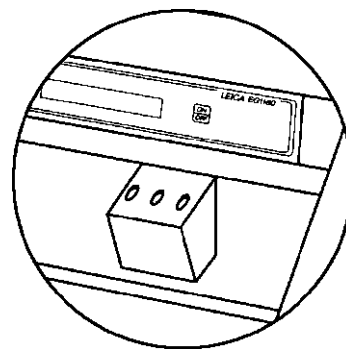

Optional accessories

Magnifier (24)

When correctly mounted, the magnifier can be swung horizontally and vertically. When correctly adjusted, both the paraffin dispenser outlet and the refrigeration spot are in focus, thus avoiding frequent readjustment to orient small and delicate biopsies.



Vacuum attachment (25)

The optional vacuum attachment can be used instead of the cassette bath, which is a standard accessory. The vacuum lid allows for vacuum infiltration of the tissue while stored in the wax bath - that means complete infiltration of the tissue in less time.

The vacuum pump (not included) is connected to the connecting branch (27). Care should be taken that the lid (26) is seated flat on the cassette bath. The seal of the lid must be free of paraffin to ensure tightness so that a vacuum can build up. To improve the tightness, the lid should be pushed on to the cassette bath when the vacuum pump starts to operate.

A vacuum can be generated only if the aeration knob (28) is shut. After infiltration, the lid cannot be opened immediately. First, the knob (28) has to be opened slowly to allow normal pressure to establish inside.

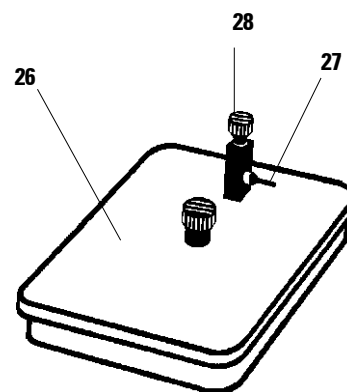

Note:

After infiltration, the vacuum should be neutralised very slowly, as air entering too rapidly could cause hot paraffin to splash and therefore should be avoided.

Fiber optical light guide for connection to the coldlight sources of Leica CLS series

To optimally illuminate the dispensing area, a fiber optical light guide with a cold light source can be used.

9. Controls / Display





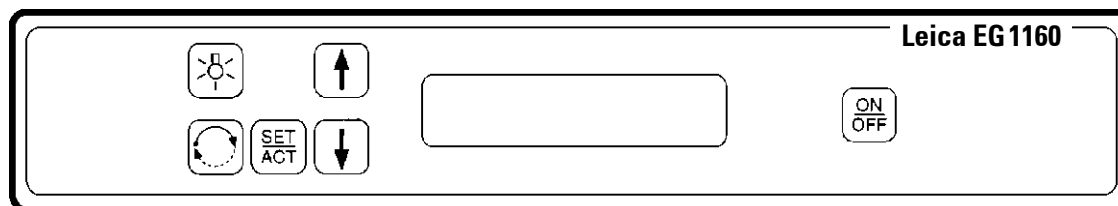

Control panel (1)

The control panel with push buttons and the 2-line display (2) is protected with a PE foil.



Push button functions

Depending on the mode of operation - initialisation, programming, operation - some of the push buttons have multiple functions:

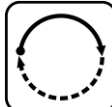
	Initialisation	ACT Mode (Operation)	SET Mode (Programming)
	Standby ↓ To turn instrument ON: ACT mode status line (= default reading)	To turn instrument ON/OFF	a) Deactivation or reactivation of the previously selected temperature b) Programming of the workdays
	Language selection (only after turning on with the main switch on the back)	Adjustment of the paraffin flow rate	Setting of variable parameters (temperature, day, time)
		ACT mode ↔ SET mode	
		Illumination ON/OFF	Illumination ON/OFF
		Scrolling through the menu	Scrolling through the menu

For details on operation and programming please refer to chapter 10 "Operation".



Please ensure that all preparatory steps described in chapter 11 have been completed:

1. Putting the instrument into operation after delivery

Turn the instrument on with the main switch (green toggle switch in the lower right corner on the back of the instrument) while pushing the ARROW UP button on the control panel for approx. 2 seconds. Then push the ON/OFF button. The instrument will then be initialised.

The main switch should always remain in ON position even after daily work. In daily routine, the tissue embedding center is turned on/off by pushing the ON/OFF button on the control panel.

Turning on again after several weeks

When the instrument had been switched off with the main switch and was out of use for several weeks, please pursue the same procedure as described above.

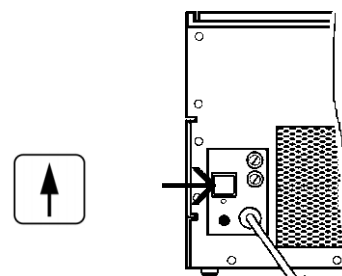

2. After initialisation, the language selection reads in the display. The desired language (E, G, F, I, S) can be selected within 10-15 seconds pushing the ARROW UP/ARROW DOWN buttons. Once the button is released the selected language is stored automatically.



3. Approximately 10 seconds after releasing the ARROW button the instrument automatically switches over to the standby. In the standby condition, the display is not illuminated. In the lower line of the display reads actual day and actual time as well as the current paraffin quantity level. The upper line remains empty.

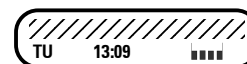

Day Time Quantity



4. The Leica EG 1160 is put into operation by pushing the ON/OFF button. This button must be held down for approx. 10 seconds. This feature protects against unintended setting into operation. The instrument will then be ready for operation in the ACT mode.

Default reading

Push one of the ARROW buttons to display the FLOW RATE reading. In order to obtain a smooth, bubble-free paraffin flow, the flow rate should first be set to 100% pushing one of the ARROW buttons. Push the dispenser handle backward or press the foot pedal until the paraffin flow is smooth and free of bubbles.

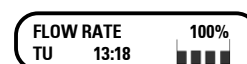
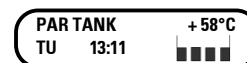

The Leica EG 1160 has two modes of operation: the actual operating mode (ACT) and the programming mode (SET). To change from one mode to the other, push the ACT/SET button.

10. Operation



ACT Mode (Operation)

5. Normal operation of the Leica EG 1160 takes place in the ACT mode. In this mode, all display readings are actual values.

Starting from the default reading (PAR TANK +XX°C), each step of the 5-step **menu** of the temperature controllable functional units can be displayed to review the actual temperature by scrolling the menu with the **MENU** button:

The status line always is the same.

All display readings both in the **ACT** and **SET** (programming) mode automatically return to the ACT default reading after approximately 10 seconds:

- 5.1 The **ILLUMINATION** of the work area is switched ON/OFF with the **LAMP** button.

- 5.2 The **PARAFFIN FLOW RATE** is individually adjustable and can be preselected in the ACT mode with the **ARROW** buttons in 10% increments.

5.3 Adjustment of the FLOW QUANTITY

The flow quantity for the lowest flow rate (10%) can be adjusted as required. All other flow rate increments will then be recalculated on this basic adjustment and stored automatically.

1. Set the flow rate to 10% by pushing the **ARROW** buttons in the ACT mode.
2. On pushing the **SET/ACT** button the display reads:
3. Operate the pump manually or with the foot pedal and push the **ARROW** buttons to readjust the flow quantity for the 10% flow rate. The new values will be stored automatically.

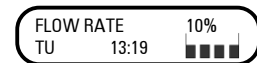
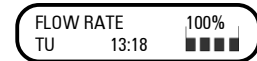
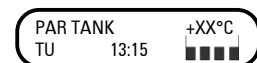
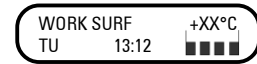
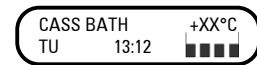
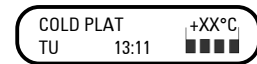

Decrease the flow rate to 10%



ADJUST FLOW RATE 10%



Increase/decrease the flow rate



ACT Mode (Operation)

5.4 The paraffin flow rate is selectable in 10% increments:

10 %, 20 %, 30 %, 40 %, 50 %, 60 %, 70 %, 80 %, 90 %, 100 %

The display reading will change with the selected flow rate. It always reads the percentage flow rate selected.



Increase/decrease of the flow rate

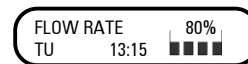

How to quit the display reading "FLOW RATE":

1. Approximately 10 seconds after having selected the flow rate, the display will automatically return to the ACT default reading.
2. Pushing the **MENU** button will also lead to the ACT default reading.
3. Pushing the **SET/ACT** button will lead to the programming mode (SET mode).
Note: If a flow rate of 10% is selected, the SET/ACT button will lead to the programming mode "ADJUST FLOW RATE" (see 5.3).

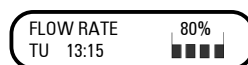

10 sec

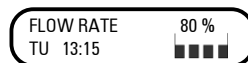
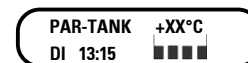
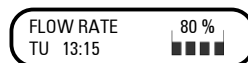

5.5 **SWITCHING OFF** with the **ON/OFF** button

By pushing the ON/OFF button, the instrument automatically returns to the standby condition.

It is **not** necessary to switch the tissue embedding center **off with the main switch**. If switched off with the main switch, all programmed parameters are maintained. In this case, however, the program will not be activated.

In the SET mode, the **ON/OFF** button has an additional function for the programming of temperatures and workdays (see 6.1, 6.4).

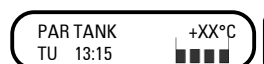

10 sec

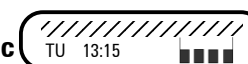



SET Mode (Programming)

6. The SET mode is activated by pushing the SET/ACT button. The SET mode is used for **programming** only. The programmable parameters are as follows:



- Paraffin reservoir temperature
- Cold plate temperature
- Cassette bath temperature
- Mold warmer temperature
- Work area temperature
- Actual day
- Actual time
- Planned start time
- Planned finishing time
- Workdays

The instrument is programmed to have all functional units ready to operate at the preselected time on the preselected workdays, i.e. all heated and refrigerated components are turned on automatically so that they will have reached the preselected temperatures when the operator starts working (*see chapter 4 "Technical data"*).

The **MENU button** is used to **scroll through** the individual items of the menu.

Once the last item of the menu ("WORKDAYS ARE ..") is reached, the first item ("SET TEMPERATURES: PAR TANK") will be indicated again after pressing the MENU button.

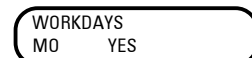
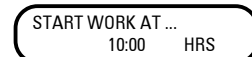
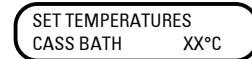
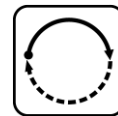

etc. ...



SET Mode (Programming)

The **ARROW buttons** are used to preselect the temperature, time and days. The speed of the display increases (1-2 step mechanism), the longer the button is held down.



6.1 TEMPERATURE SETTING

The temperature is preselected with the ARROW buttons. Once the minimum or maximum value is reached, the indication will stop. The value displayed when releasing the ARROW button will be stored automatically, and heating and cooling will be activated accordingly.



The individual temperature settings can be activated or deactivated with the **ON/OFF button**.



ON:

The previously entered temperature reads in the display. If the current value is not changed, the microprocessor will adjust the temperature to the displayed value.



OFF:

The temperature control function can be switched off if no specific temperature is required. The previously entered temperature remains in the memory but will not be activated.



The display reads:



In this case, the default reading is as follows:

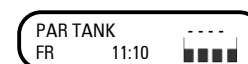

6.2 ACTUAL TIME / DAY

Actual time and day are set with the ARROW buttons. An endless search mechanism provides that the search run restarts from the beginning automatically after attaining 23:59 or SUN.

The time/day indicated on releasing the ARROW buttons will be stored automatically.

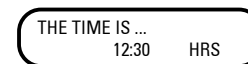
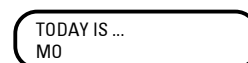

6.3 BEGINNING AND END OF WORK

The time when you start and stop work is selected with the ARROW buttons. The endless search mechanism provides that the search run automatically restarts from the beginning after attaining 23:59. Thus the instrument will be operational on all days of the week defined as workdays (see 6.4) at the previously selected time. The time indicated on releasing the ARROW buttons will be stored automatically.

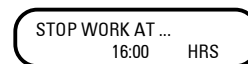



SET Mode (Programming)

6.4 WORKDAYS

The workdays are selected with the ARROW buttons. Releasing the button, the indicated day will be put in the memory automatically. The **ON/OFF button** is used to confirm if the program shall be activated (YES) or not (NO) the day indicated in the display.

If the programming of workdays is not desired, i.e. if the user can do entirely without the automatic turn-on function of the tissue embedding center, "NO" must be entered for each day of the week.

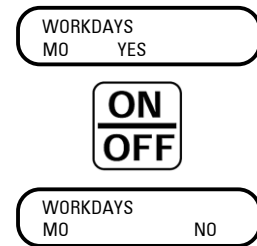

6.5 How to quit the programming (SET) mode

1. 10 seconds after activation of any of the buttons, the instrument will automatically return to the ACT mode (default reading). This feature is a protection against unintended programming.



10 sec

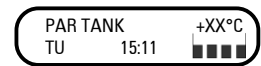

2. Pushing the SET/ACT button will also lead to the ACT mode.

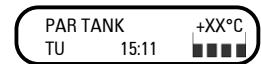

The flow rate cannot be selected in the SET mode. It can only be selected in the ACT mode.

AUTOMATIC TURN-ON FEATURE

If this feature is not used, it should be ensured that the tissue embedding center is turned on early enough to allow all components to reach the appropriate temperatures to avoid unnecessary delays. Especially the paraffin reservoir heater should be turned on early enough, as it can take some hours until the wax is molten. The individual warmup times are listed in chapter 4 "Technical data".

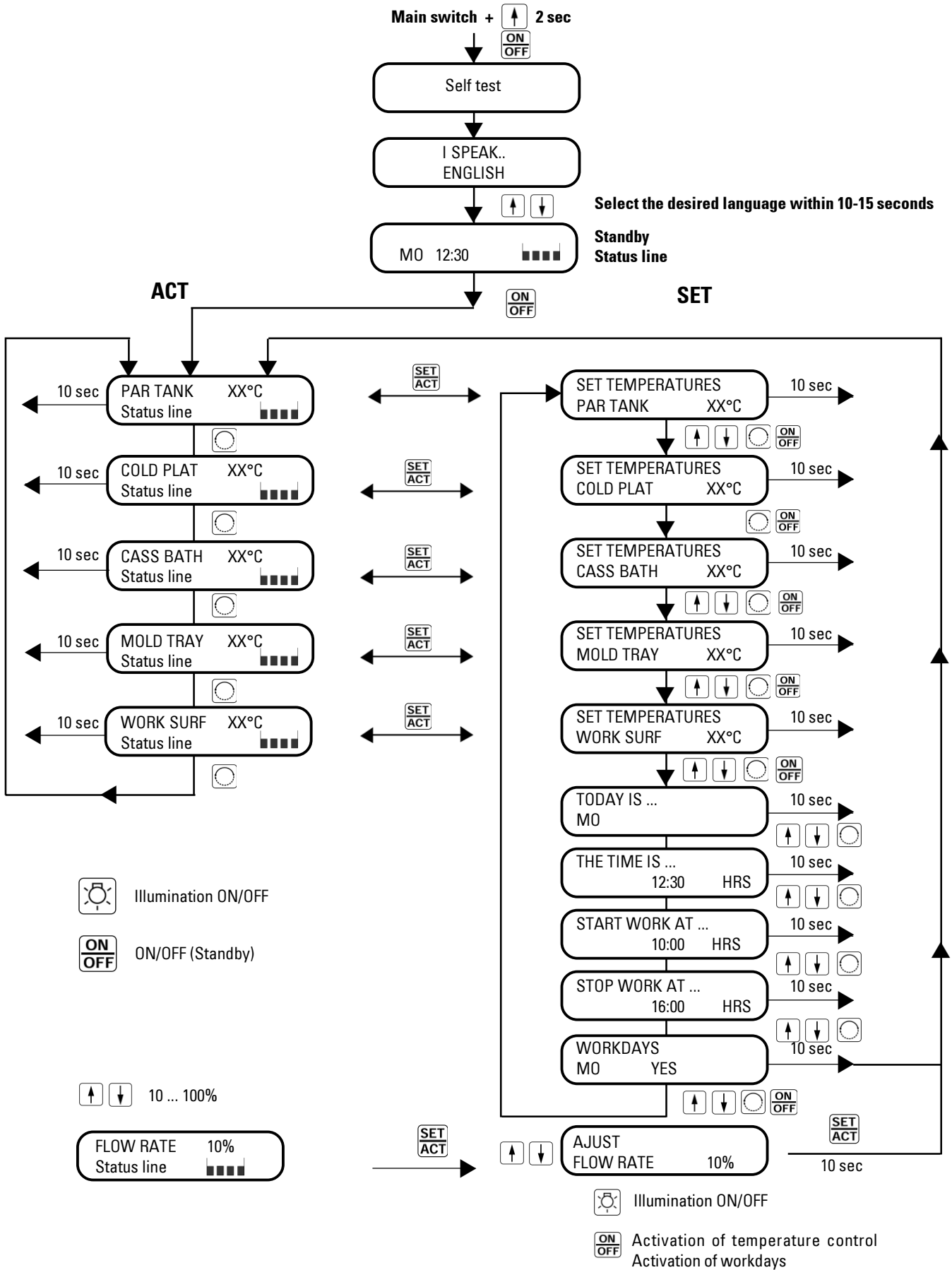

11. Tissue embedding

The paraffin reservoir is filled with wax pellets (e.g. Leica HISTO-WAX). The level of the molten wax should reach up to 2-3 cm under the upper edge of the reservoir.

When the symbol for "paraffin tank on reserve" is displayed, there is still approximately 1 litre left. However, the paraffin reservoir should be re-filled immediately at that stage.

The set temperature for the paraffin reservoir should be set to a value between the melting point and the maximum value indicated by the manufacturer of the paraffin that is used.

Once all functional units have reached the preselected temperatures and the wax in the paraffin reservoir is completely molten, tissue embedding can begin.

Note:

Overheating of the molten wax must be avoided as important components can be damaged resulting in damage to the sample.

1. The embedding cassettes containing the dehydrated and infiltrated tissue sample are transferred to the cassette bath (approx. 100 cassettes), which is filled with molten wax to prevent the solidification of the wax.

The cassette bath temperature is optimally maintained constant when it is filled with molten paraffin.

If the cassette bath is not filled with wax, it should not be filled with cassettes up to the top edge, as a film could form on the cassettes at the top reducing the quality of the embedding.

By use of the optional vacuum attachment for the cassette bath, the tissue can be infiltrated under vacuum. The vacuum is generated by a vacuum pump that is connected to the connecting branch on top of the vacuum lid. The seal of the lid must be free of paraffin to be seated flat on the cassette bath to allow for the vacuum to build up. To improve the tightness, the lid should briefly be pushed on to the cassette bath when the vacuum pump is turned on. After infiltration, the lid cannot be opened immediately. The aeration knob has first to be opened slowly (!) to allow for pressure equalisation inside.

2. The embedding molds are placed in the mold warmer.

Note:

Overheating of the molds must be avoided as this could cause problems when removing the block from the mold.

The molds should be clean and dry. First, the molds should be treated with xylene, then with soap solution and finally rinsed with distilled water and dried.

3. Take three to four cassettes out of the cassette bath and, depending on the work method, either place them on the work area to allow liquid paraffin to drop and immediately remove them from the mold, or transfer them to the heated recessed area filled with molten wax for intermediate storage to prevent immediate solidification of the infiltrated specimen. This applies in particular to small biopsies. If the heated recessed area is not filled with wax, it provides additional space on the work area.

4. Select an appropriate embedding mold, place it under the dispenser outlet nozzle and fill it with paraffin as required:

- a. using the foot pedal
- b. manually, by pushing the paraffin dispenser handle
- c. when filling larger molds, the dispenser handle can be retracted, thus providing enough clearance under the paraffin outlet nozzle. The flow is adjustable in 10 increments.



5. Open the cassette and transfer the sample to the mold using warm forceps.

6. The mold is placed on the refrigeration spot for a moment. The tissue is oriented with forceps as required. Within a few seconds, the clear consistency of the wax will change.

Small tissue specimens can be oriented by slowly pushing the mold from the embedding spot to the refrigeration spot. As the wax solidifies very slowly in the transition area, the tissue can be removed from the forceps without any risk that the sample sticks to the tip of forceps. (If the wax becomes solid too rapidly, the forceps will stick to the tissue).

Note: Please avoid a film to form on the surface of the paraffin. This would create two phases in the finished block which could cause fissures inside as a result of which the block could break during sectioning.

7. After orientation of the specimen, the half filled mold is retransferred to the embedding spot. After positioning a cassette base or an embedding ring, the mold is filled up with paraffin.

When not using cassettes or embedding rings, the mold should be filled up to the top edge.

Note: Do not overfill the mold to avoid contaminating the cassette base or embedding ring outside as this could result in the insufficient clamping in the specimen holder of the microtome.

8. Place the mold on the cold plate. The wax will become entirely solid within a short time. Finally, the paraffin block including the specimen can be easily removed from the mold.

All steps should be performed without delays to ensure that the wax homogeneously solidifies in the mold to prevent the formation of layers, which could affect the sectioning results.

Please note that the removable tray where excess paraffin is drained should be emptied at regular intervals to ensure that liquid paraffin drains easily and the removable tray does not stick to the guides.

Caution! The tray can be hot!

Excess paraffin collected in the removable tray should not be reused, as it would be contaminated.

9. On termination of embedding, the Leica EG 1160 should be turned off pushing the ON/OFF button. Condensation water on the cold plate should be wiped off and liquid paraffin removed from the work area with soaking paper. *For further information on cleaning and maintenance, please refer to chapter 12.*

Note: The tissue embedding center need not be turned off with the green main switch on the back. If it is programmed to automatically turn on in advance, it **must not** be switched off with the main switch.

When the automatic turn-on feature is not used, please make sure that the instrument is turned on early enough to allow the individual components to reach the required temperatures. This applies particularly to the heater of the paraffin reservoir, as it can take several hours until the solid wax is entirely molten. The warmup times of the individual components are listed in *chapter 4 "Technical data"*.

12. Cleaning, maintenance, service



Regular cleaning and maintenance will keep your Leica EG 1160 in good operating condition for many years.

1. General instructions: Paraffin

- Paraffin is flammable and therefore must be handled with care. Avoid spillage of liquid paraffin.



- All Leica EG 1160 components that come into contact with paraffin and the interior of the instrument are carefully sealed to prevent wax from entering. Nevertheless, if paraffin is spilled, it should always be removed carefully.

- The paraffin reservoir and cassette bath, if required, should be filled with care. Avoid overfilling!



- The wax in the cassette bath and heated recessed area must be exchanged every day to avoid contamination.

- Solid wax particles on the surface of the work area must not be removed with sharp tools, as this could damage the finish. A soft plastic spatula is ideal for wax removal. Alternatively, solid paraffin can be lifted off easily by lightly warming it.

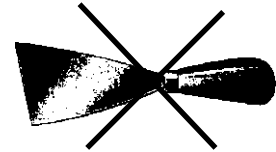

- The surfaces of the work area of the Leica EG 1160 are made of aluminium with polyester epoxy finish. The control board is covered with a PE film. The base of the housing is a polyester epoxy coated steel plate. All seams are sealed with a specific fungicidal silicone.

All materials are easy to clean with common laboratory detergents, which are appropriate for paraffin removal. Do not allow organic solvents to react for a longer period. Apply varnish protection occasionally.



Caution:

Xylene must **not** be used for cleaning. Although xylene is an ideal wax solvent, its flash point ranges between 27 and 32°C. Xylene vapours are heavier than air and can catch fire even if the source of heat is at a larger distance. Therefore, it is not appropriate for cleaning hot or potentially hot surfaces. Risk of fire!





2. Cleaning of paraffin reservoir, filter and dispenser outlet

The grid separating solid from liquid wax and the filter can be removed from the paraffin reservoir for cleaning. The reservoir is cleaned inside with a paper tissue.

Care should be taken that the reservoir is contaminated. Any dirt inside should be removed prior to removing the grid and the filter.



3. Cleaning the forceps holder

The forceps holder, in particular, is frequently a source of contamination and is susceptible to dirt. Therefore it should be cleaned thoroughly.

Caution:

The forceps holder is heated separately and thus very hot (approx. 70°C or 80°C) during operation.



4. The paraffin drained to the **paraffin collection tray** should be emptied regularly to ensure that excess paraffin can drain to the tray and prevent the removable tray from sticking to guide.

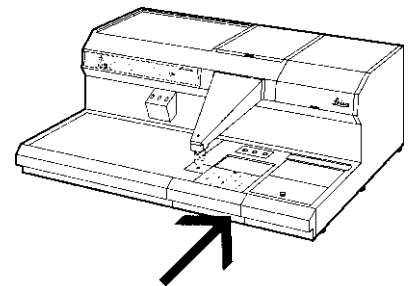

5. Illumination of the dispenser outlet

Prior to exchanging the light bulb, the Leica EG 1160 must be turned off with the green main switch on the back. Remove the cap at the front end of the dispenser. The light bulb can be removed pulling it toward the user. The replacement bulb is inserted by lightly pushing it between the contacts.

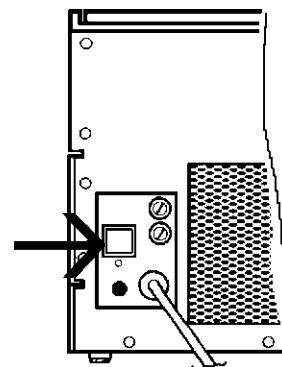

6. Fuses

See "Technical data". Replacement fuses must meet the specifications of the manufacturer. Otherwise, this could invalidate the warranty!



13. Troubleshooting

Whenever a malfunction occurs, please ensure that it is not the result of an operating mistake.

The list below includes the most frequent operating errors.

Equipment malfunctions are indicated as error messages (error codes 1 to 13) in the LCD display. If such an error code is displayed, please contact your local Leica service center.

FUNCTIONAL UNIT	SYMPTOM	CAUSE	ACTION
Initial operation	Instrument does not turn on	Main switch (on the back) not in ON position ON/OFF button pushed not long enough	Turn on main switch Hold down ON/OFF button for some seconds
Paraffin reservoir	Paraffin quantity level indication does not correspond to the actual quantity Paraffin does not melt Temperature readout incorrect or no heating	Paraffin not entirely molten Selected temperature too low? Heater not activated? Wrong temperature selected? Instrument failure	Wait until the wax is molten completely; then check again. Increase temperature of paraffin reservoir Check if paraffin reservoir heater is activated Check temperature setting and activation Technical service
Paraffin dispenser	No paraffin flow	Paraffin not entirely molten Foot pedal not properly connected	Check the consistency of the wax in the reservoir and wait for some time if necessary Check foot pedal connection

13. Troubleshooting

FUNCTIONAL UNIT	SYMPTOM	CAUSE	ACTION
Paraffin dispenser	No paraffin flow	Foot pedal / dispenser valve switch failure	Technical service
	Paraffin drops when valve closed	Valve / pump failures	Technical service
	No heating	Heater (paraffin reservoir) not activated	Activate heater (paraffin reservoir)
		Heater failure	Technical service
	No illumination	Lamp defective	Replace lamp
Inhomogeneous paraffin flow (e.g. air bubbles)	Air bubbles in dispenser at the start	Push dispenser handle for a while until flow is homogeneous	
	Pump failure	Technical service	
Mold warmer Cassette bath Work area	Wrong temperature indication	Wrong temperature selected	Check temperature setting
	No heating	Heater not activated	Activate heater
		Heater failure	Technical service
Vacuum attachment (optional accessory)	No vacuum buildup. Vacuum deteriorates too rapidly	Lid not properly positioned	Check if lid is properly (op)positioned
		Seal of lid contaminated	Check seal
		Aeration knob open	Check knob adjustment
		Seal untight	Technical service
Forceps holder	No heating	Heater failure	Technical service

13. Troubleshooting

FUNCTIONAL UNIT	SYMPTOM	CAUSE	ACTION
Cold plate	Insufficient cooling	Ambient temperature too high?	Check temperature at lower ambient temperature
		Leak in cooling system?	Technical service
		Air supply to compressor insufficient?	Clean condenser fins (Technical service)
	Compressor does not start	Compressor failure	Technical service
	Compressor stops after short operation	Compressor failure	Technical service
	Compressor stops after short operation and restarts after a short while	Compressor failure	Technical service

Telephone number of your local *Leica* sales office:
MICROSYSTEMS



14. Ordering information

	Catalog Number
Leica EG 1160 Paraffin embedding center	
Basic instrument	115 V/60 Hz 0386 30527
	230 V/50 Hz 0386 30528
Model with additional forceps holder on the left	115 V/60 Hz 0386 30351
	230 V/50 Hz 0386 30352
Additional cassette bath 0386 19544
Magnifier 0386 21462
Replacement bulb 0187 21220
Vacuum attachment 0386 21980
Stoppers (pack of 10) 0386 24782
Fiber optical light guide without coldlight source 0386 31352
Coldlight source Leica CLS 100 -	100 V, 50/60Hz 0502 30213
	120 V, 50/60Hz 0502 30214
	230 V, 50/60Hz 0502 30215
	240 V, 50/60Hz 0502 30216
Embedding cassettes without lid, 250 pcs, white 0394 12312
"	grey 0394 08972
"	yellow 0394 08974
"	red 0394 08976
"	green 0394 08978
"	blue 0394 08980
Lids for cassettes, 250 pcs,	white 0394 12315
"	grey 0394 08982
"	red 0394 08986
"	green 0394 08988
"	blue 0394 08990
Biopsy cassettes, 250 pcs,	white 0394 08966
Lids for biopsy cassettes, 250 pcs,	white 0394 08970
Deep lids for cassettes for samples up to 12 mm high, 250 pcs, white 0394 12767
Embedding rings, 1000 pcs,	white 0386 12392
Embedding molds for samples up to	7 x 7 x 5 mm 0386 12302
"	15 x 15 x 5 mm 0386 12303
"	24 x 24 x 5 mm 0386 12304
"	30 x 24 x 5 mm 0386 12305
"	37 x 24 x 5 mm 0386 12306
Embedding molds, deep version, for samples up to 24 x 24 x 12 mm 0386 12860
"	37 x 24 x 12 mm 0386 12861
Marker pencil for marking of cassettes and embedding rings 0386 12300
Filing box for convenient storage of cassettes, lids, molds and embedding rings 0394 12398
Plastic storage cabinet with 4 drawers for cassettes or rings 0386 12393
Embedding frames, size 1, 56 x 40 x 26 mm (adjustable) 0339 06427
Embedding frames, size 2, 34 x 26 x 18 mm (adjustable) 0339 06432
Base plate for Catalog No. 0339 06427 or Catalog No. 0339 06432 0339 06438
Paraflex embedding mold for 8 samples 25 x 25 x 25 mm each 0339 10963
Paraflex embedding mold for 4 samples 40 x 40 x 30 mm each 0339 10961
Embedding mold for plastics, flexible but stable in form, 8 recesses 25 mm \varnothing , 4 of which with gate for specimen orientation, 19 mm deep 0379 12698
Embedding medium JUNG-Histowax, 1 bag = 2.5 kg 0374 08585
Large bag (25 kg) 0374 14374

15. Warranty and service

Warranty

Leica Microsystems Nussloch GmbH guarantees that the contractual product delivered has been subjected to a comprehensive quality control procedure based on the Leica in-house testing standards, and that the product is faultless and complies with all technical specifications and/or agreed characteristics warranted.

The scope of the warranty is based on the content of the concluded agreement. The warranty terms of your Leica sales organization or the organization from which you have purchased the contractual product shall apply exclusively.

Technical service information

If you require technical service or replacement parts, please contact your Leica sales representative or dealer who sold the product.

Please provide the following information:

- Model name and serial number of the instrument.
- Location of the instrument and name of the person to contact.
- Reason for the service call.
- Date of delivery.

Decommissioning and disposal

The instrument or parts of the instrument must be disposed of in compliance with the local laws.